



This manual covers the following models:

- **T631-2**

## Thermostat Applications Guide

Description	
Gas or Oil Heat	Yes
Electric Furnace	Yes
Heat Pump (No Aux. or Emergency Heat)	Yes
Heat Pump (with Electric Aux.)	Yes
Heat Pump (with Gas Aux.)	No
Multi-stage Systems	No
Heat Only Systems	Yes
Heat Only Systems - Floor or Wall Furnaces	Yes
Cool Only Systems	Yes
High and Low Fan Speed	Yes
Millivolt	No
Emergency Heat	No
Conventional Single Stage Furnace	Yes
Geothermal	Yes

## Table of Contents

## Page

Installation Tips	2
Thermostat Quick Reference	3
Thermostat Sub-base Installation	4
Wiring	5-6
Technician Setup	7
Technician Setup Menu	8
Mount Thermostat & Battery Installation	9
Specification & Contact Information	10

## Power Type

Battery Power

Hardwire (Common Wire)

Hardwire (Common Wire) with Battery Backup

**A trained, experienced technician must install this product.**

Carefully read these instructions. You could damage this product or cause a hazardous condition if you fail to follow these instructions.

## Need Help?

For assistance with this product please visit <http://www.pro1iaq.com> or call Pro1 Customer Care toll-free at 888-Pro1iaq (776-1427) during normal business hours (Mon-Fri 9 AM - 6 PM Eastern)

Una versión española de este manual puede ser descargada en [www.pro1iaq.com](http://www.pro1iaq.com)

### Wall locations

---

The thermostat should be installed approximately 4 to 5 feet above the floor. Select an area with average temperature and good air circulation.

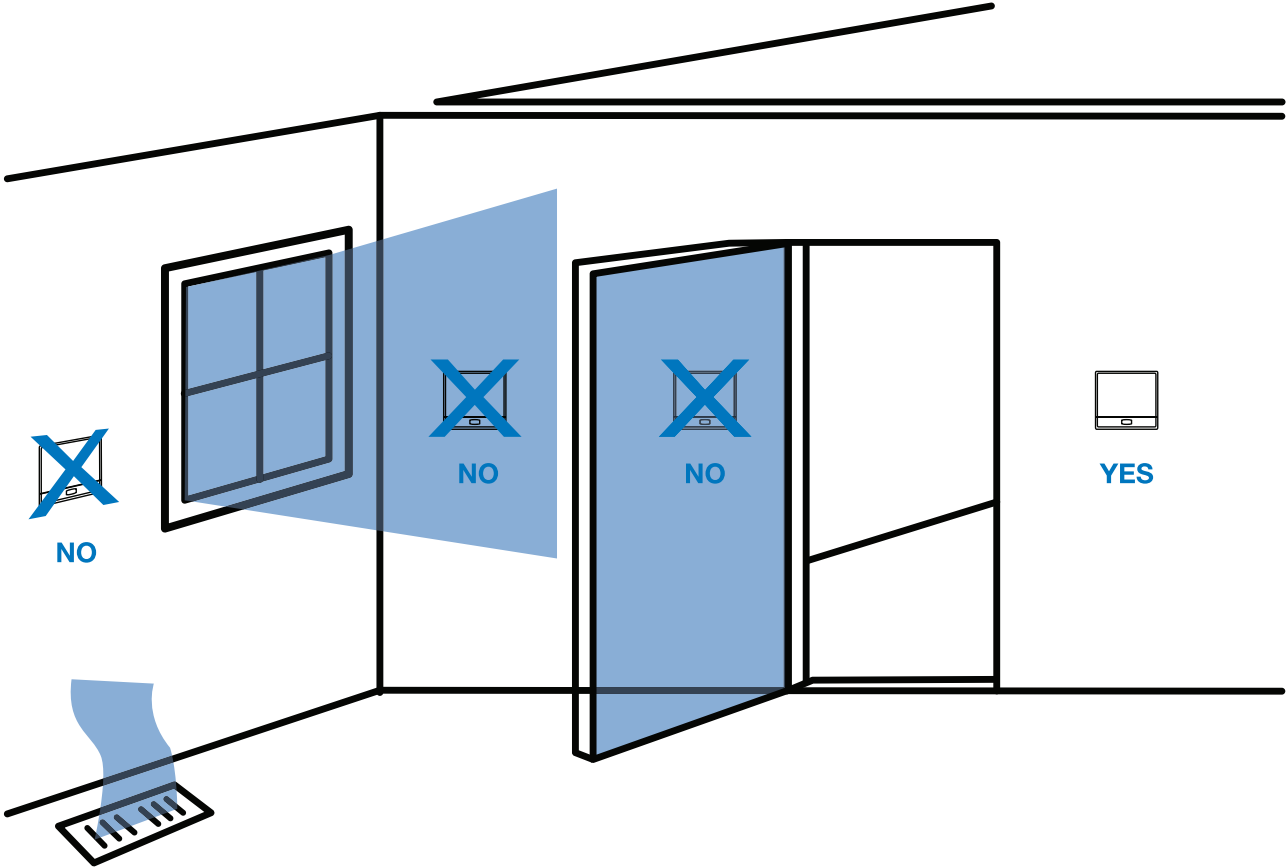

**Do not install** thermostat in locations:

- Close to hot or cold air ducts
- That are in direct sunlight
- With an outside wall behind the thermostat
- In areas that do not require conditioning
- Where there are dead spots or drafts (in corners or behind doors)
- Where there might be concealed chimneys or pipes

### PRO1 Tip

---

Pick an installation location that is easy for the user to access. The temperature of the location should be representative of the building.

## Getting to know your thermostat

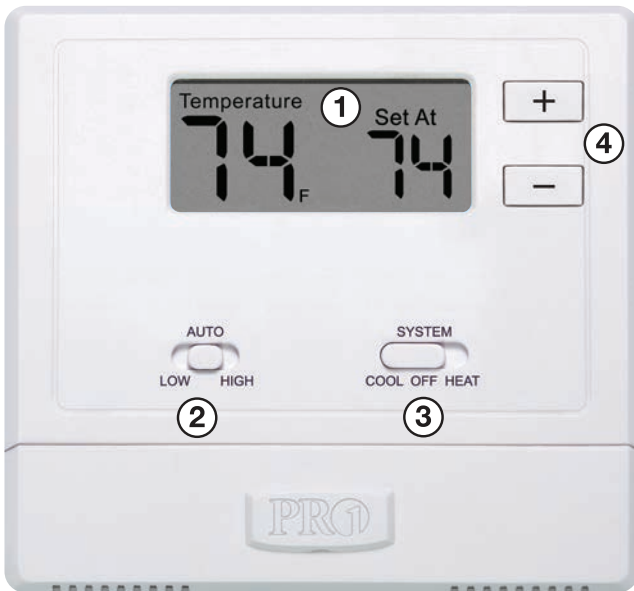

### ① LCD

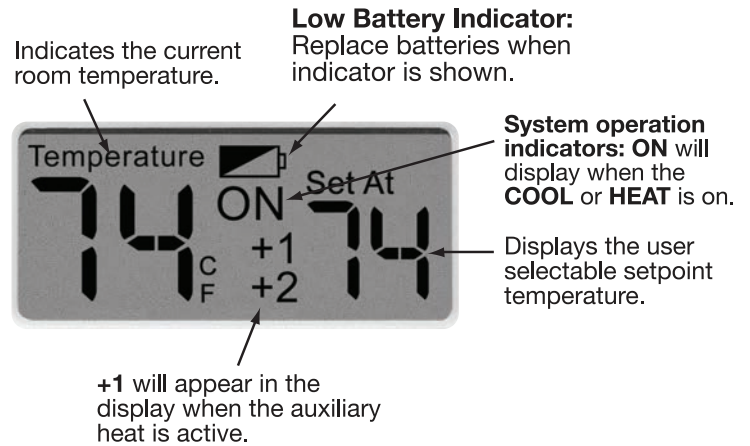

- ② Fan Switch
- ③ System Switch
- ④ Setpoint Buttons



### Important:

The low battery indicator is displayed when the AA battery power is low. If the user fails to replace the battery within 21 days, the thermostat display will only show the low battery indicator as a final warning before the thermostat becomes inoperable.

## Removing the private label badge

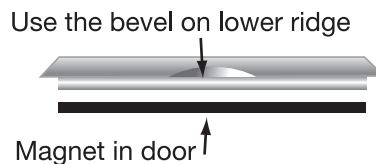

Gently slide a screwdriver into the bottom edge of the badge. Gently turn the screwdriver counter clockwise. The badge is held on by a magnet. The badge should pry off easily. **Do not use force.**

### PRO1 Tip

All Pro1 thermostats use the same universal magnetic badge. Visit our website at [www.pro1iaq.com](http://www.pro1iaq.com) to learn more about our free private label program.

# INSTALLATION MANUAL

## THERMOSTAT SUB-BASE INSTALLATION



### Caution: Electrical Hazard

Failure to disconnect the power before beginning to install this product can cause electrical shock or equipment damage.



### Mercury Notice:

All of Pro1's products are mercury free. However, if the product you are replacing contains mercury, dispose of it properly. Your local waste management authority can give you instructions on recycling and proper disposal.

For vertical mount put one screw top and one screw bottom.

For horizontal mount put one screw left and one screw right.

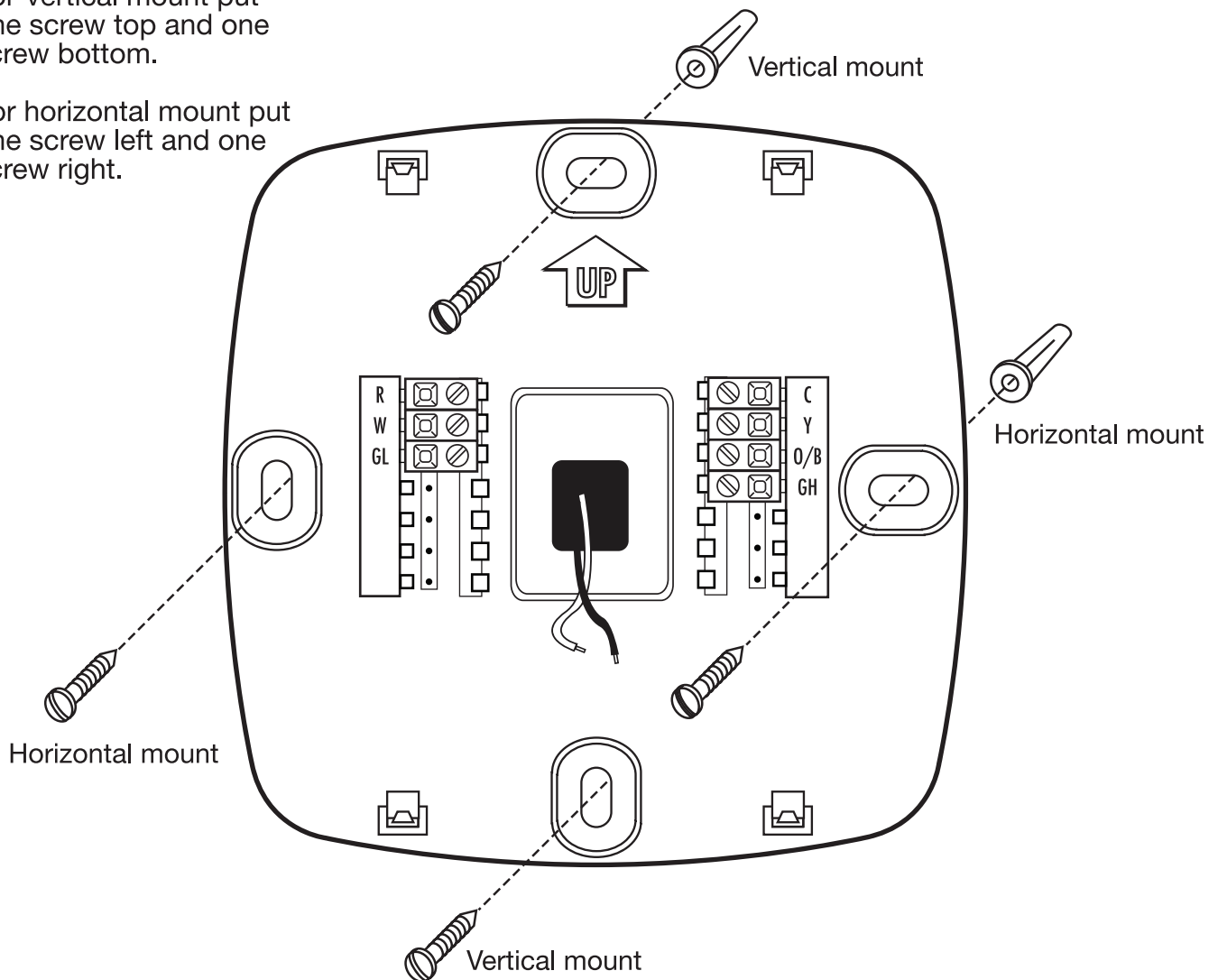

### PRO1 Tip

It is recommended that the thermostat be hardwired (C and R terminals connected to 24V power supply), however, it is not required. Batteries should be checked annually if 24V power is not connected.

## Wiring

1. If you are replacing a thermostat, make note of the terminal connections on the thermostat that is being replaced. In some cases the wiring connections will not be color coded. For example, the green wire may not be connected to the **G** terminal.
2. Loosen the terminal block screws. Insert wires then retighten terminal block screws.



### Warning:

All components of the control system and the thermostat installation must conform to Class II circuits per the NEC Code.

#### Wire specifications

Use shielded or non-shielded 18 - 22 gauge thermostat wire.



### Caution:

#### Electrical Hazard

Failure to disconnect the power before beginning to install this product can cause electrical shock or equipment damage.

## Terminal Designations on T631-2 Thermostat

This thermostat is shipped from the factory to operate a conventional heating and cooling system. This thermostat will also operate a heat pump system. See the “heat pump” configuration step on page 8 of this manual to configure the thermostat for heat pump applications.

Terminal	1 Heat 1 Cool Conventional System	1 Heat 1 Cool Heat Pump System	2 Heat 1 Cool Heat Pump System
<b>R</b>	Transformer power	Transformer power	Transformer power
<b>C</b>	Transformer common	Transformer common	Transformer common
<b>B</b>	Energized in heating	Heat pump changeover valve energized in heating	Heat pump changeover valve energized in heating
<b>O</b>	Energized in cooling	Heat pump changeover valve energized in cooling	Heat pump changeover valve energized in cooling
<b>GL</b>	Fan relay, Low	Fan relay, Low	Fan relay, Low
<b>GH</b>	Fan relay, High	Fan relay, High	Fan relay, High
<b>W</b>	First stage of heat	NA	Second stage of heat
<b>Y</b>	First stage of cool	First stage of heat & cool	First stage of heat & cool

### Connecting to a PTAC:

When connecting the T631-2 to a PTAC, refer to the PTAC manufacturer instructions to enable remote thermostat operation.

- 1 Power supply
- 2 Jumper (not supplied) to connect GL and GH terminals
- 3 The thermostat must be set to O or B to match the changeover valve, O is cool changeover valve, B is heat changeover valve.
- 4 The Aux Heat Relay is energized as the second stage of heat.

**Typical 1H/1C system: 2 speed fan**

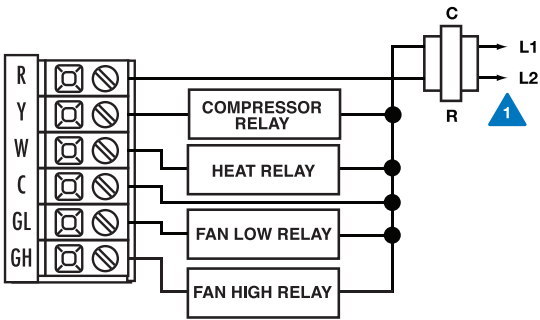

**Typical 1H/1C system: 1 speed fan**

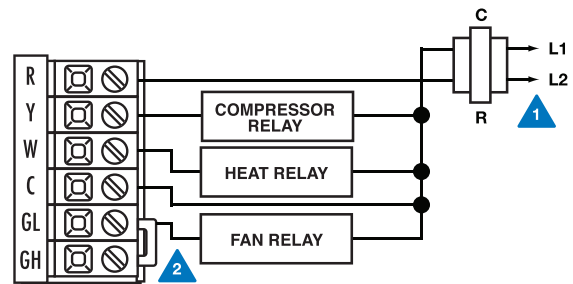

**Typical 1H/1C Heat Pump system: 2 speed fan**

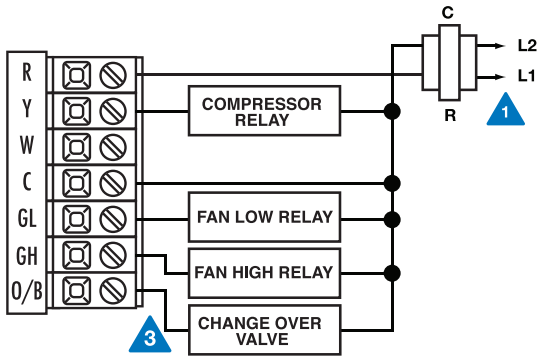

**Typical 2H/1C Heat Pump system: 2 speed fan**

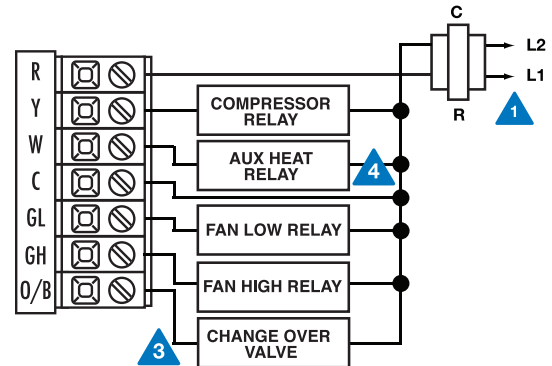

**Note:**

Most PTAC systems support two speed fan operation. In a single speed fan PTAC system or conventional single speed fan system, a jumper should be installed between GL and GH on the thermostat.

### Fan Operation Setup

**Electric:** The thermostat operation jumper pin should be put in the **ELEC** position. This setting allows the thermostat to operate the fan during a call for heat. Most PTAC systems will require **ELEC** Fan Operation Setup.

**Gas:** For systems that control the fan during a call for heat, put the jumper pin in to the **GAS** position.

### Fahrenheit/Celsius Display

Select **F** or **C** with the jumper pin to select desired display.

### Compressor Short Cycle Delay

The compressor short cycle delay protects the compressor from “short cycling”. This feature will not allow the compressor to be turned on for 5 minutes after it was last turned off.

Using the jumper on the back of the thermostat, selecting **ON** will not allow the compressor to be turned on for 5 minutes after the last time the compressor was on. Selecting **OFF** will remove this delay.

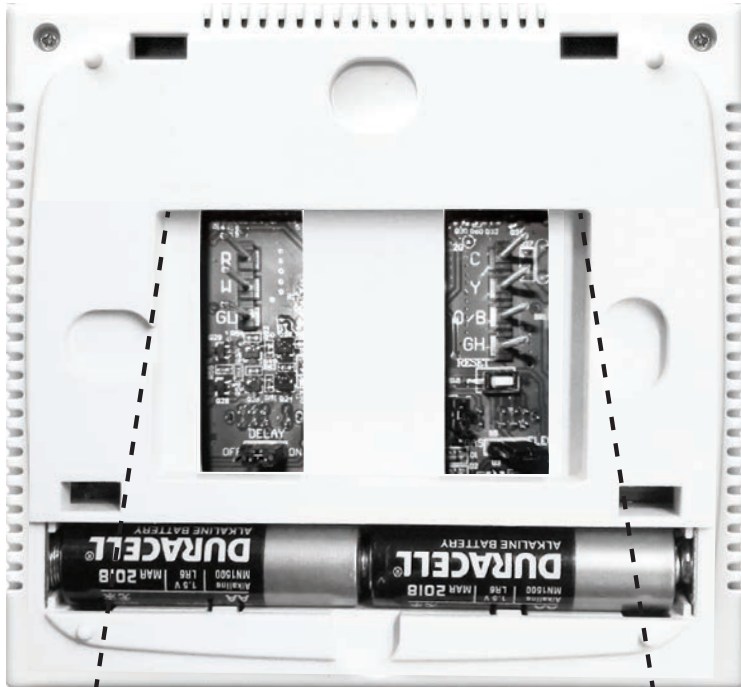

Select **F** or **C** with the jumper pin

Reset button

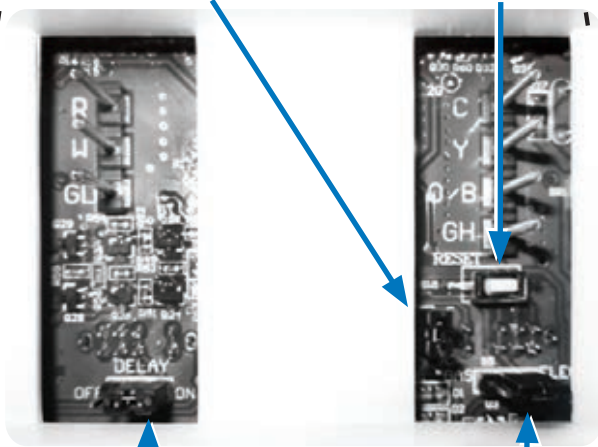

Select delay **ON** or **OFF** with the jumper pin

Select **ELEC** or **GAS** with the jumper pin



#### Important:







The **RESET** button must be pressed after changing any jumper pin setting. Batteries must be installed for this operation.







# INSTALLATION MANUAL





## TECHNICIAN SETUP MENU

Follow these steps to configure this thermostat to fit your particular application:

1. Set the thermostat system switch to **OFF**.
2. To enter Tech Setup Menu, press and hold  and  together for 3 seconds.
3. Use  or  to select desired setting for each option.
4. Tap  and  together to move to next option.
5. To exit Tech Setup Menu, move system switch or wait 15 seconds.

To enter the Cooling and Heating Swing adjustment modes:

1. Set the thermostat system switch to the desired position (**COOL** or **HEAT**).
2. Press and hold  and  together for 3 seconds.
3. Use  or  to adjust desired swing setting.  
The display reads in tenths of a degree.
4. To exit, move system switch or wait 15 seconds.

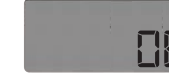
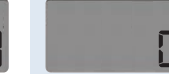
Tech Setup Options					Swing Settings	
Room Temperature Calibration	Change Over Valve Selection	Heat Pump	Heating Temperature Setpoint Limit	Cooling Temperature Setpoint Limit	Cooling Swing (SYSTEM COOL)	Heating Swing (SYSTEM HEAT)
This feature allows the installer to change the calibration of the room temperature display. For example, if the thermostat reads 70° and you would like it to read 72° then select +2.	Select <b>0</b> for a changeover valve that energizes in cooling. Select <b>b</b> for a change over valve that energizes in heating.	When turned on the thermostat will operate a heat pump.  Y will be first stage of heat & cool, W will be second stage heat.	This feature allows you to set a maximum heat setpoint value. The setpoint temperature cannot be raised above this value.	This feature allows you to set a minimum cool setpoint value. The setpoint temperature cannot be lowered below this value.	The swing setting, often called "cycle rate", "differential" or "anticipation" is adjustable. A smaller swing setting will cause more frequent cycles and a larger swing setting will cause fewer cycles.	The swing setting, often called "cycle rate", "differential" or "anticipation" is adjustable. A smaller swing setting will cause more frequent cycles and a larger swing setting will cause fewer cycles.
LCD Will Show						
						
Adjustment Options						
You can adjust the room temperature display to read -4°F to +4°F above or below the factory calibrated reading.	<b>0</b> for cooling changeover valve  <b>b</b> for heating changeover valve	OFF configures the thermostat for non heat pump systems.  ON configures the thermostat for heat pump systems.	45.0 °F - 90.0 °F	45.0 °F - 90.0 °F	The cooling swing setting is adjustable from ±0.2°F to ±2°F. For Example: A swing setting of 0.5°F will turn the cooling on at approximately 0.5°F above the setpoint and turn the cooling off at approximately 0.5°F below the setpoint.	The heating swing setting is adjustable from ±0.2°F to ±2°F. For Example: A swing setting of 0.5°F will turn the heating on at approximately 0.5°F below the setpoint and turn the heating off at approximately 0.5°F above the setpoint.
Factory Default Settings						
0 °F	0	OFF	90 °F	45.0 °F	0.8 °F	0.8 °F

### PRO1 Tip

The second stage will turn on at 2x the swing setting. The second stage will turn off when 1x the swing is reached. For example, if the swing setting is 0.8° for heating and the thermostat is set at 70°F, the first stage will turn on at approximately 69.2°F. The second stage will turn on at 68.4°F. The second stage will turn off at 69.2°F and the first will turn off at 70.8°F.



# INSTALLATION MANUAL

## MOUNT THERMOSTAT & BATTERY INSTALLATION

### Mount Thermostat

Align the 4 tabs on the subbase with corresponding slots on the back of the thermostat, then push gently until the thermostat snaps in place.



### Battery Installation

Battery installation is optional if thermostat is hardwired (R and C terminal connected to 24v power).

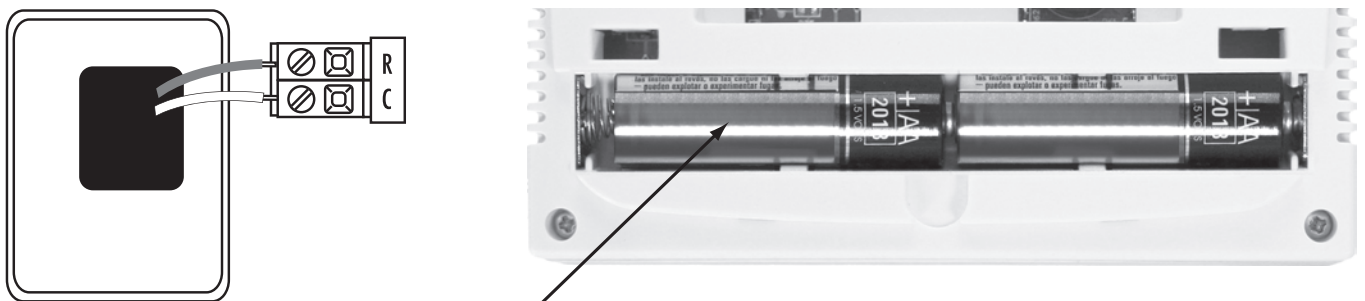

Insert 2 AA Alkaline batteries (included).

### Specifications

---

#### T631-2 Thermostat

The display range of temperature .....	41°F to 95°F (5°C to 35°C)
The control range of temperature .....	44°F to 90°F (7°C to 32°C)
Load rating .....	1 amp per terminal, 1.5 amp maximum all terminals combined
Display accuracy .....	± 1°F
Swing (cycle rate or differential) .....	Heating is adjustable from 0.2°F to 2.0°F Cooling is adjustable from 0.2°F to 2.0°F
Power source .....	18 to 30 VAC, NEC Class II, 50/60 Hz for hardwire (common wire) Battery power from 2 AA Alkaline batteries
Operating ambient .....	32°F to +105°F (0° to +41°C)
Operating humidity .....	90% non-condensing maximum
Dimensions of thermostat .....	4.7"W x 4.4"H x 1.1"D

### Contact Us

---

#### Pro1 IAQ Inc.

1111 S. Glenstone  
Suite 2-100  
Springfield, MO 65804

**Toll-free:** 1-888-Pro1iaq (776-1427)

**Toll Number (Outside the USA):** 330-821-3600

**Web:** <http://www.pro1iaq.com>

**Hours of Operation:** Monday - Friday 9 AM - 6 PM Eastern